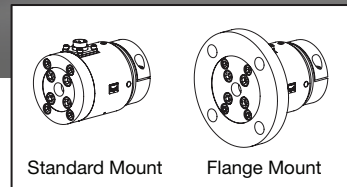

# DR-D Series

## Drop In Replacement 3-Pin Dead Shaft Load Cells

**IP54**

### Montalvo DR-D Series - Drop In Replacement 3-Pin Dead Shaft Load Cells

As alternatives to DFE's Model C Tension Transducers, Montalvo's DR-D Series feature integrated 3-pin connectors while meeting DFE product dimension specifications. In addition to being direct, drop-in replacements, Montalvo's DR-D load cells feature mechanical variance compensation with a stainless steel construction to give you maximum performance and a long service life. DR-D load cells are available in multiple load ratings, two mounting configurations, and three different body sizes to meet the specific requirements of your application.

#### Features & Benefits

- ▶ *Industry Leading Resolution* - and sensitivity for superior accuracy and response
- ▶ *Drop In Replacement Design* - in three sizes to meet the dimensional requirements of your machine
- ▶ *Integrated 3-Pin Connector* - to match existing wiring configurations
- ▶ *Multiple Mounting Options* - standard or flange to fit most any machine frame
- ▶ *Stainless Steel Construction* - and dust proof (IP54) rating for durability and an extended, dependable service life
- ▶ *Mechanical Variance Compensation* - for shaft expansion and misalignment from installation variables
- ▶ *360° Overload Protection*

# DR-D Series

Drop In Replacement 3-Pin Dead Shaft Load Cells

## Dimensions

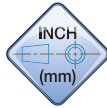

### Standard Mount (S)

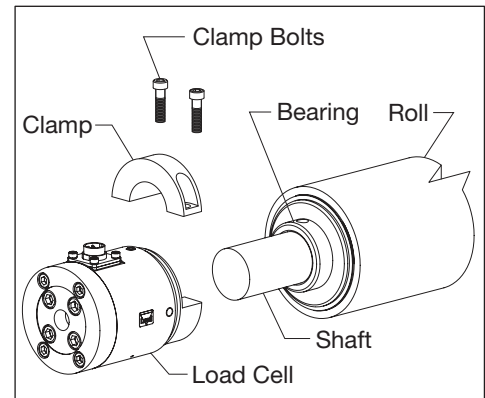
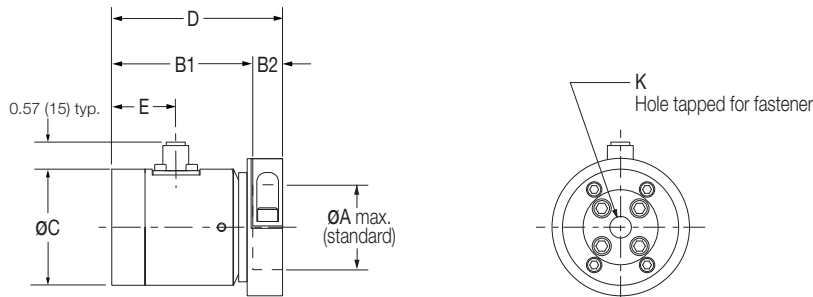

Model	A	A(metric option)	B1	B2	C	D	E	K	K(metric option)
DRD-I-S0	1.50	40mm	2.44 (62.1)	0.57 (14.4)	1.988 (50.5)	3.02 (76.7)	1.16 (29.5)	3/8"-16 x 0.55"	M10-1.5x14
DRD-I-S1	1.50	40mm	2.61 (66.3)	0.57 (14.4)	2.26 (57.5)	3.18 (80.8)	1.20 (30.5)	1/2"-13 x 0.59"	M12-1.75x15
DRD-I-S2	1.75	40mm	3.00 (76.2)	1.00 (25.4)	2.85 (72.5)	4.00 (101.6)	1.22 (31)	5/8"-11 x 0.63"	M16-2.0x16

### Flange Mount (F)

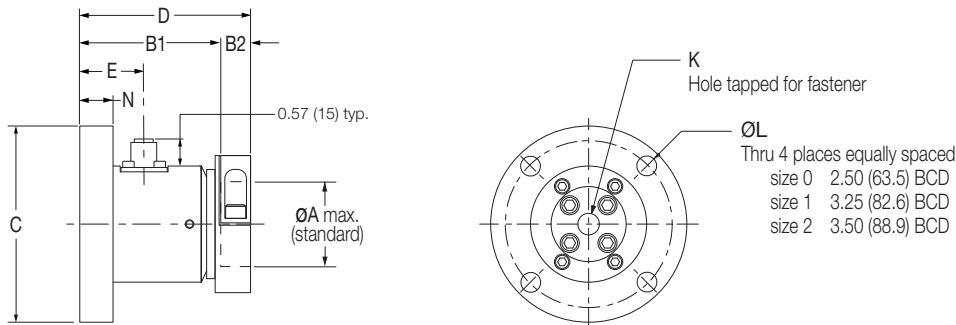

Model	A	A(metric option)	B1	B2	C	D	E	K	K(metric option)	L	N
DRD-I-F0	1.50	40mm	2.44 (62.1)	0.57 (14.4)	3.12 (79.2)	3.02 (76.7)	1.16 (29.5)	3/8"-16 x 0.55"	M10-1.5x14	0.354 (9)	0.375 (9.5)
DRD-I-F1	1.50	40mm	2.61 (66.3)	0.57 (14.4)	4.00 (101.6)	3.18 (80.8)	1.20 (30.5)	1/2"-13 x 0.59"	M12-1.75x15	0.433 (11)	0.59 (15)
DRD-I-F2	1.75	40mm	3.00 (76.2)	1.00 (25.4)	4.49 (114)	4.00 (101.6)	1.22 (31)	5/8"-11 x 0.63"	M16-2.0x16	0.551 (14)	0.63 (16)

### Note: Pillow Block Mounted Load Cells

DR-D bodies are designed to fit within existing pillow block mounts. If you require a new pillow block mount, please let us know.

## How To Specify

### Series

DR-D, ES, N, or U

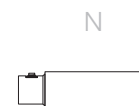

### Shaft / Shaft Size in (mm)

I- Dead Shaft Idler Roller consisting of the following components:  
 Shaft \_\_\_\_\_  
 Bearing \_\_\_\_\_  
 Roller \_\_\_\_\_

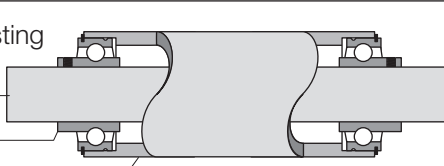

Maximum shaft size

Size 0 1.125" (25mm)  
 Size 1, 2 1.750" (40mm)

Bushings available for other size shafts at no charge.

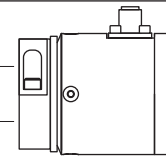

### Mount

S or F

S (standard)

F (flange)



### Size

0, 1 or 2

Consider the following:  
 Load rating, shaft size, dimensions and replacement mounting

0	1	2
Lower Loads Smaller Shafts Smaller Dimensions	Lower Loads Smaller Shafts Smaller Dimensions	Higher Loads Larger Rollers Larger Dimensions

### Connector Position

6 (standard)  
 3, 9 or 12 (available upon request)

Position is relative to LOAD ARROW (except P mount), which is always 6, as observed from clamp end of load cell.

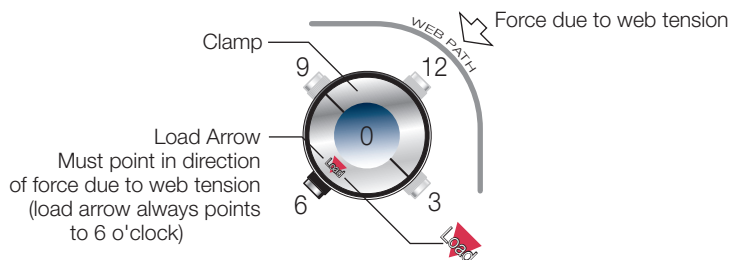

### Load Rating lb (N)

Size 0 10(50), 25(125), 50(250), 75(375), 100(500), 150(750)  
 Size 1 50(250), 75(375), 100(500), 150(750), 250(1250)  
 Size 2 75(375), 100(500), 150(750), 250(1250), 500(2500), 1000\*(5000)\*

$F_t$  points ABOVE horizon

$F_t$  points BELOW horizon

$F_t$  is HORIZONTAL

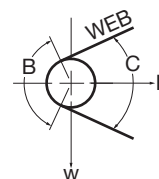
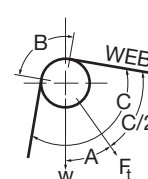
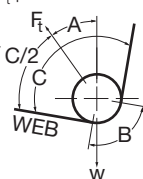

$$LR = \frac{4P \sin(B/2) - W \cos(A)}{2}$$

$$LR = \frac{4P \sin(B/2) + W \cos(A)}{2}$$

$$LR = \frac{4P \sin(B/2)}{2}$$

- LR load rating
- P maximum tension (pull) on web
- B wrap angle
- W weight of roller in pounds
- A angle between  $F_t$  and vertical axis
- C angle between entering and exiting web
- F resultant force

\* For F mount only.

Note: It is recommended that Montalvo be contacted to ensure proper sizing.

### Example

**DR-D - I - F 2 - 6 - 500lb - 1.750 in**

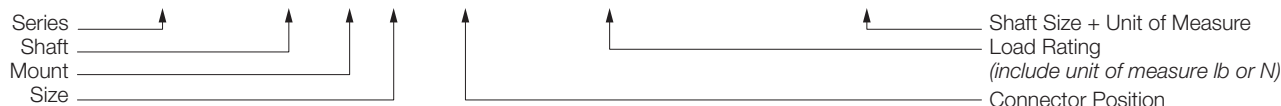

# Montalvo DR-D Series

Drop In Replacement 3-Pin Dead Shaft Load Cells

## Wiring

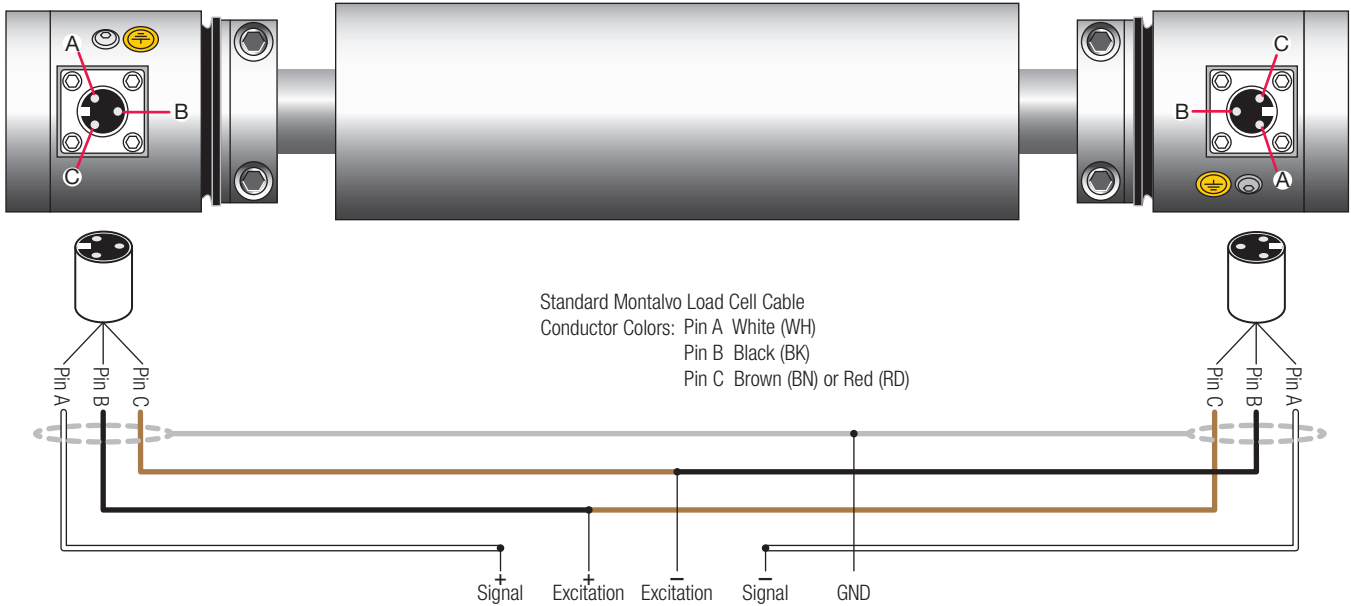

## Specifications

### Electrical

Excitation.....5 VDC  
Output..... 250 mV, nominal @ full load  
Gauge Resistance..... 80 - 130  $\Omega$   
Type ..... half bridge semi-conductor  
Non-Repeatability.....  $\pm 1/4\%$  full span  
Non-Linearity and Hysteresis (combined).....  $\pm 1/2\%$  full span

### Connector

Type ..... Amphenol MS3106A-10SL-3S  
Pin A..... Signal  
Pin B ..... Excitation  
Pin C ..... Excitation

### Load Ratings - lb (N)

Size 0 .....25(125), 50(250), 75(375), 100(500), 150(750)  
Size 1 .....50(250), 75(375), 100(500), 150(750), 250(1250)  
Size 2 .....75(375), 100(500), 150(750), 250(1250), 500(2500), 1000\*(5000)\*  
Overload Stops ..... 110% of Load Rating  
Overload Rating..... 300% of Load Rating

\* For F and P mounts only.

Note: It is recommended that Montalvo be contacted to ensure proper sizing.

### Environmental

Classification .....IP54  
Temperature  $^{\circ}\text{F}$  ( $^{\circ}\text{C}$ )  
Operating range ..... -4 to +150 (-20 to +70)  
Coefficient (% per degree)..... 0.02 (0.01) typ.

### Mechanical

Deflection in (mm)..... 0.008 to 0.015 (0.203 to 0.381)  
Alignment .....  $1^{\circ}$  max.  
Bore\*\* Size 0 ..... 1-1/2" or (40 mm) std.  
Size 1 ..... 1-1/2" or (40 mm) std.  
Size 2 ..... 1-3/4" or (40 mm) std.

\*Bushings available for smaller shaft sizes.

Finish ..... stainless steel

### Common Replacement Units

DRD-I-S-0 replaces ..... DFE C-0-D-S  
DRD-I-S-1 replaces ..... DFE C-1-D-S  
DRD-I-S-2 replaces ..... DFE C-2-D-S

## Related Montalvo Products

Tension Controllers  
Load Cell Amplifiers  
Tension Indicators  
and... Cables

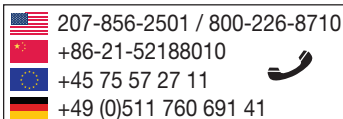

The Montalvo Corporation

EST. 1947

**montalvo**

Better Web Control®

50 Hutcherson Drive, Gorham, Maine 04038 USA  
Fax: 1-800-644-5097 / 207-856-2509

1-800-226-8710 / info@montalvo.com / www.montalvo.com

Technical details subject to change without notice. DRDI-US-7 © Montalvo